

**SIEMENS**

# Siemens Industry Industry Automation / Drive Technologies

Kompanija i organizacija

Portfolio

Alati za lakši odabir opreme

Tehnička podrška



## Siemens u Srbiji - Prekretnice

- **1887 - 1904** – izgrađene su prve Siemens elektrane i u rad su pušteni prvi sistemi rasvete u Beogradu, Nišu, Šapcu, Užicu.
- **1898** - Siemens je opremio pogone i osvetljenje Narodnog pozorišta u Beogradu
- **1902** – prvi rendgen aparat u Šapcu
- **1908** – prva hidroelektrana u Ivanjici
- **1922** – prvih 30 tramvaja u Belgradu
- **1959 - 1996** – Siemens postaje aktivan učesnik u raznim projektima u oblasti telekomunikacije, industrijske automatizacije, saobraćaja, proizvodnje i distribucije električne energije takođe je ostvario kooperaciju i saradnju sa domaćim kompanijama (Elektronska industrija Niš/Belgrade, Jugodent Novi Sad, FSU Belgrade, etc.)



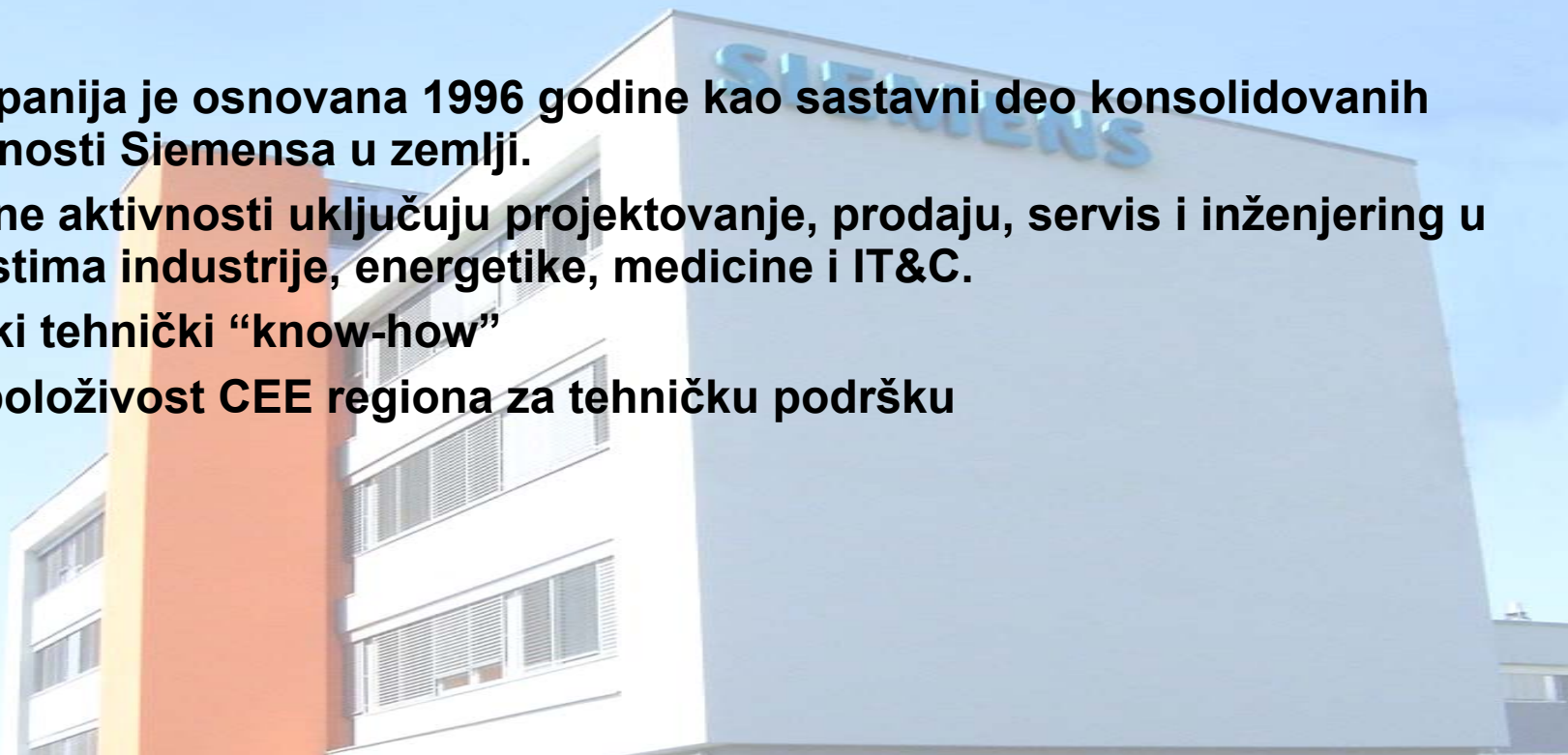

## Siemens d.o.o. Beograd

- **Kompanija je osnovana 1996 godine kao sastavni deo konsolidovanih aktivnosti Siemens u zemlji.**
- **Glavne aktivnosti uključuju projektovanje, prodaju, servis i inženjering u oblastima industrije, energetike, medicine i IT&C.**
- **Visoki tehnički “know-how”**
- **Raspoloživost CEE regiona za tehničku podršku**



# Siemens organizacija

## Aktivnosti u tri sektora

Industry	Energy	Healthcare	Cross-sector activities
			
Industry Automation	Fossil Power Generation	Imaging & IT	IT Solutions and Services
Drive Technologies	Renewable Energy	Workflow & Solutions	Siemens Financial Services
Building Technologies	Oil & Gas	Diagnostics	
Osram	Service Rotating Equipment		
Industry Solutions	Power Transmission		
Mobility	Power Distribution		

# Industry Sector Organizacija

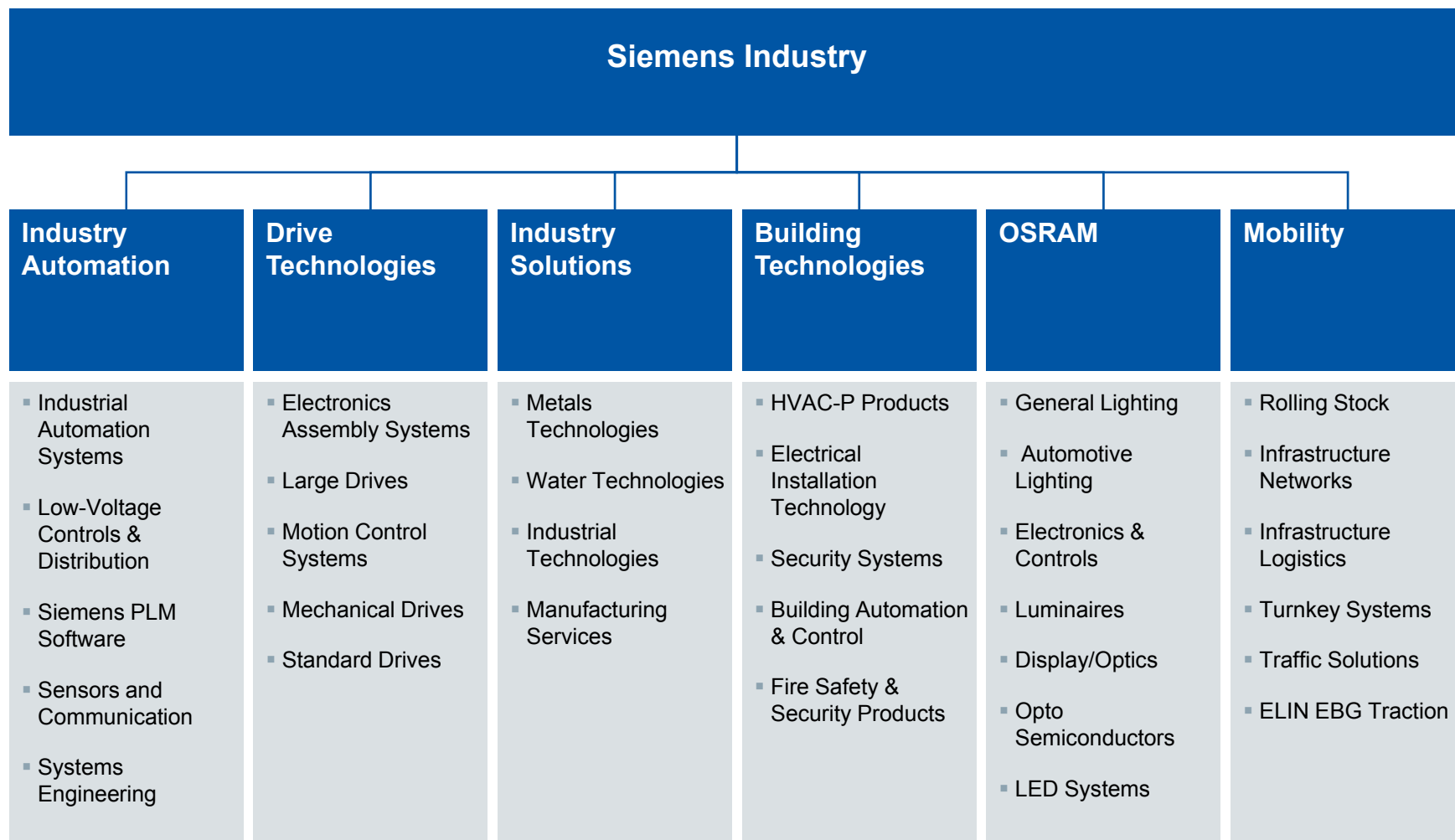

## Industrijski sistemi za automatizaciju

### Portfolio:

Integrisan spektar proizvoda i sistema za automatizaciona rešenja u svim sektorima; rešenja za proces proizvodnje, inženjering i projektovanje fabrika u procesnoj industriji

### Jezgro automatizacije:

SIMATIC S7 (Kontroler); SIMATIC HMI (nadzor, upravljanje i vizuelizacija) sistemi; SIMATIC PCS 7 sistem za upravljanje procesima; MES rešenja pomoću SIMATIC IT; Automatizacija na PC platformi (PC based Automation)



Pregled proizvoda →

# Industrijski sistemi za automatizaciju



# Jedinstvena integracija Totalni Integrisana Automatizacija

Totalno Integrisana Automatizacija pruža jedinstvena, standardna rešenja za prilagodljive sisteme za automatizaciju

- [za svaku granu industrije](#)
- za celokupan [proizvodni proces](#)
- sa jasnim prednostima a svaku fazu proizvodnog procesa u [celokupnom proizvodnom procesu](#) – čuvajući visoku sigurnost investicija

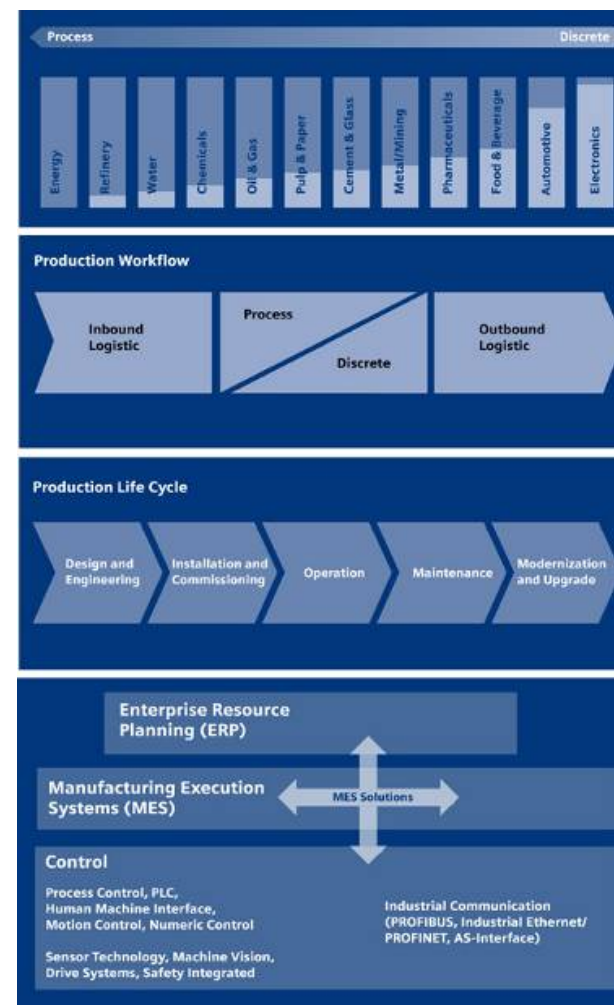



## Niskonaponska oprema

### Portfolio:

Industrijska niskonaponska, sklopna tehnika i niskonaponska distribucija električne energije

- SIRIUS industrijski prekidači; SIRIUS Sigurnosno Integrisani Koncept
- SENTRON prekidači za niskonapansku distribuciju električne energije
- SIVACON niskonapanski ormani / razvodni sistemi
- Upravljanje potrošnjom električne energije



Pregled proizvoda →

# Niskonaponska oprema

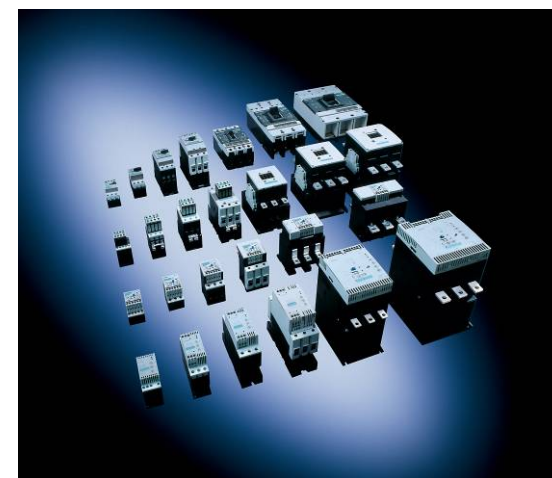
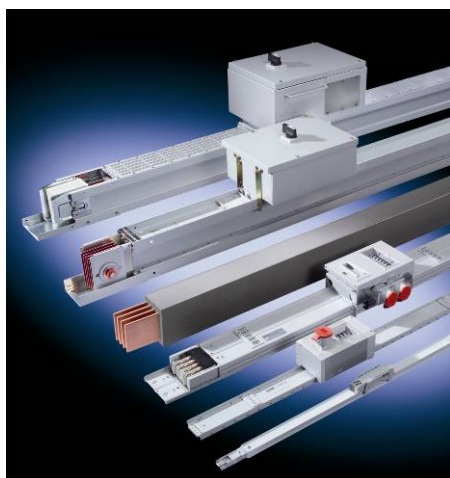
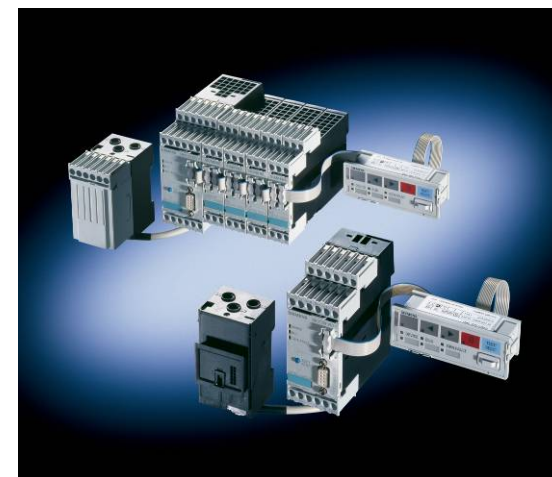

## Jedinstvena integracija Totally Integrated Power

Totally Integrated Power predstavlja spektar integrisanih proizvoda, sistema i rešenja za kompletno napajanje objekata električnom energijom

- [od srednjeg napona do utičnica](#)



# Elektro Instalaciona Tehnologija

## Portfolio:

Elektro Instalacioni proizvodi od A do Ž

## Jezgro:

ALPHA razvodni ormari i terminalni blokovi; BETA ugradni instalacioni uređaji; GAMMA sistemi za upravljanje zgradama; DELTA prekidači i utičnice



Pregled proizvoda →

# Elektro Instalaciona Tehnologija



## Senzori i komunikacije

### Portfolio:

- Procesna instrumentacija
- Procesna analitika
- Senzorska tehnologija za proizvodnu automatizaciju
- Industrijske komunikacije
- Radio moduli



Pregled proizvoda →

# Senzori i komunikacije

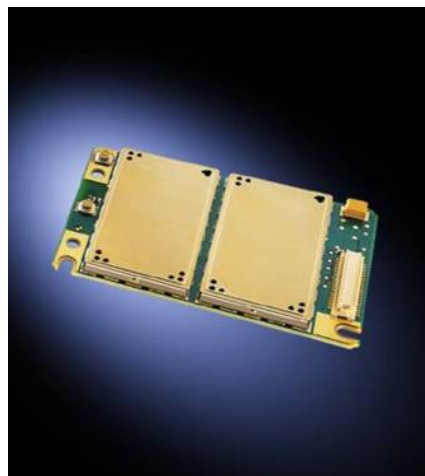

## Large Drives

### Portfolio:

Regulatori i motori velikih snaga za mašine jednosmerne i naizmjenične struje, kao i za specijalne mašine visokih performansi:

- SINAMICS low-voltage converters
- SINAMICS, SIMOVERT i ROBICON Perfect Harmony medium-voltage converters
- Low and high-voltage motors
- SIMOREG DC-MASTER converters
- DC motors
- Pogonski sistemi za železnicu

Pregled proizvoda →





# Large Drives



## Motion Control Sistemi

### Portfolio:

Motion control sistemi i rešenja za alatne i proizvodne mašine

### Jezgro:

SINUMERIK kontroleri za numeričke mašine, SIMOTION motion control sistemi, SINAMICS, MASTERDRIVES, SIMODRIVE pogonski sistemi, širok spektar servo motora



Pregled proizvoda →

# Motion Control Sistemi



## Mechanical Drives

### Portfolio:

Integracijom firme Flender AG omogućeno je proširenje proizvodnog programa u oblasti mehaničkih i električnih pogona.

Proizvodni program je proširen na oblast motor reduktora u najširim granama industrije – vetrenjačama, brodogradnji, građevinskim mašinama...



# Mechanical Drives

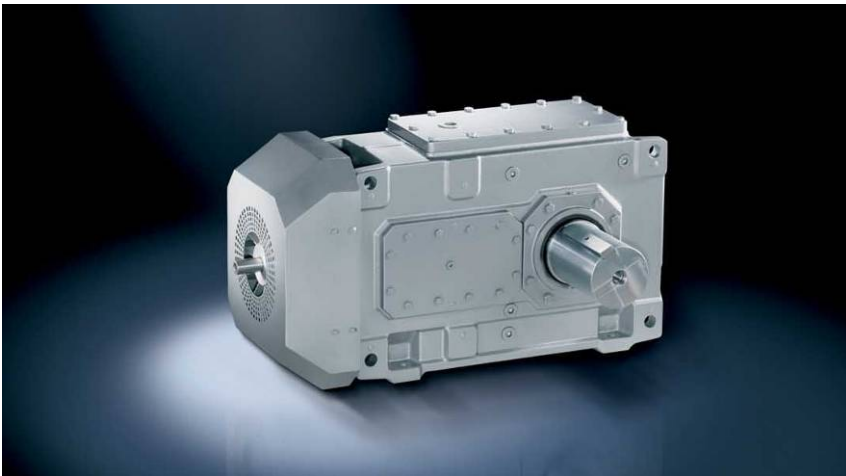

## Standard Drives

### Portfolio:

Niskonaponski motori, motor reduktori i frekventni regulatori za sve pogonske zadatke nižeg i srednjeg nivoa performansi

### Jezgro:

- Frekventni regulatori: MICROMASTER, SINAMICS, SIMATIC ET 200S FC
- Niskonaponski motori i motor reduktori



Pregled proizvoda →

# Standard Drives



**SIEMENS**

**Alati za lakši odabir  
opreme  
Tehnička podrška**





## Katalozi 01/2009 sa interaktivnim katalogom CA 01



- Katalozi u PDF-u, za sve proizvode, na jednom mestu
- Veliki broj brošura i prospekata sa detaljnim tehničkim opisima
- Smart PDF sa navigacijom
- Veliki broj alata za odabir opreme na jednom mestu

### Interaktivni katalog CA 01

Catalog CA 01- the Interactive Catalog of Industry Automation and Drive Technologies



SIEMENS

- Jednostavan i intuitivan odabir
- Kompletna tehnička dokumentacija
- Veliki broj konfiguratora
- Mogućnost izvoza podataka u MS Office
- Jednostavno pretraživanje

## Alati i uputstva za *Simatic-e*



Catalog CA 01- the Interactive Catalog of Industry Automation and Drive Technologies

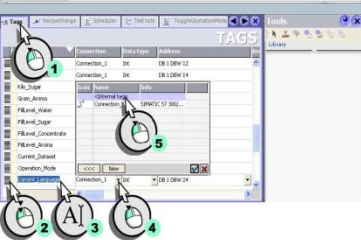

Konfigurator za Micro sisteme - LOGO! i S7-200

- On-line alat za odabir Micro sistema

[www.microautomationconfigurator.automation.siemens.com](http://www.microautomationconfigurator.automation.siemens.com)

Konfigurator za S7 u CA 01

- Konfigurisanje Simatic sistema, decentralnih periferija, mreže sa mogućnošću izvoza i provere konfiguracija u STEP 7
- Odabir pravog rešenja za vizuelizaciju

Simatic Manual-i

- Off-line baza manual-a za sve Simatic komponente

Uputstvo za konfigurisanje Simatic HMI panela na srpskom

- Detaljno korak po korak uputstvo za korisnike WinCC Flexible-a

## Alat za odabir merne opreme



### PIA Selector

- On-line alat za odabir, dimenzionisanje i proračun instrumentacije
- Provera već odabranih uređaja
- Odabir po tehnologiji i aplikaciji
- Specifikacija instrumentacije u Word ili Excel formatu...

## Alati za odabir nisko naponske i instalacione opreme



### SIMARIS Design

- Program za projektovanje nisko naponskih instalacija od srednjeg napona do utičnice
- Jednopolne šeme, struje kratkog spoja, selektivnost, detaljan predmer sa kodovima za poručivanje



### Win-Soft Starter

- Softver za dimenzionisanje, odabir i simulaciju mekih upuštača



### Alpha select

- Softver za konfigurisanje razvodnih ormara



### Delta switch manager

- Softver za odabir galanterije

## Alati za izbor pogonske tehnike



Niederspannungsmotoren und Umrichter

Anwendung in neuem Browserfenster, Start dauert ca. 1 Minute



### SPACE SD konfigurator

- Jednostavan alat za odabir nisko naponskih motora i frekventnih regulatora
- Sadrži data sheet, uputstvo za puštanje u rad, 3D i 2D skice, makroe za EPLAN...

### SIZER

- Napredni alat za detaljno dimenzionisanje *motion control* sistema, nisko i srednje naponskih motora i regulatora

## Tehnička podrška

### Service&Support

[www.siemens.com/automation/service&support](http://www.siemens.com/automation/service&support)

- Jedinствena baza manual-a, certifikata, tehničkih podataka, FAQ
- Forum
- Registracija korisnika
- Zahtev za tehničku podršku
- Odgovor su roku od 24 sata
- AVC kartica